

Model IK1 - IK2



Design Features

- Compact Design
- Anti-Static
- Low weight
- High insulation value (0.025 W/(m.K))
- Operation Temperature -60°C to $+175^{\circ}\text{C}$.
- Material: Hard PUR resin
- All corrosion resistant materials
- One size fits all assemblies

Description

The Multi Instruments Insulation Kit

The Multi Instruments Insulation Kit provides thermal and mechanical protection to the "weakest" part of any pressure hookup, being the interface between hookup and impulse lines. Often the connectors are left open and this gap results in a cold spot where liquid inside impulse lines will freeze up making the measurement fail.

The IK-1 and IK-2 insulation kit's provide a fire retardant, anti-static and high insulation value cover that connects seamless to the mounting plate on the hookup side and provides a slide over interface to the aluminum insulation cover of the impulse lines.

Example



Added Value

This option, along with options like body enclosures, junction boxes, sunshades and others are part of our total assembly capabilities.

We will fit any brand of instrument onto the appropriate manifold including options and test, tag and ship it to site for "Plug-and-Play" installation by the field contractor.

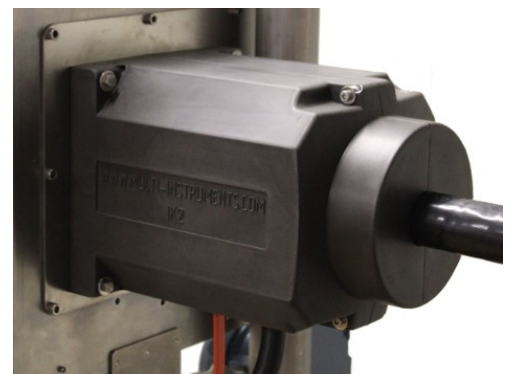

Head Office: ☎ +31 (0)183 62 88 88 or ✉ to: instrumentation@multi-instruments.com

US + Canada: ☎ +1 587 269 49 88 or ✉ to: solutions@multi-instruments.com

for additional information: 🌐 www.multi-instruments.com

Model IK1 - IK2

Model selection guide

IK1

Model Description

- IK1 Insulation Kit 1

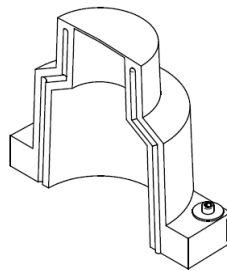
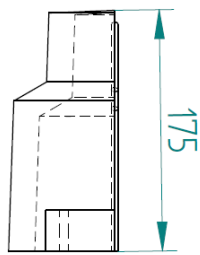
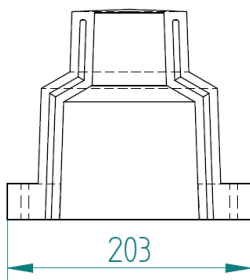

IK2

Model Description

- IK2 Insulation Kit 2

Left side view

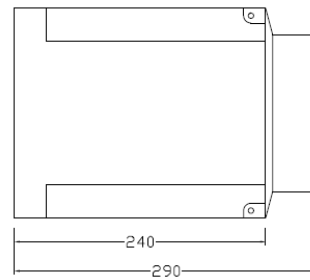

Front view

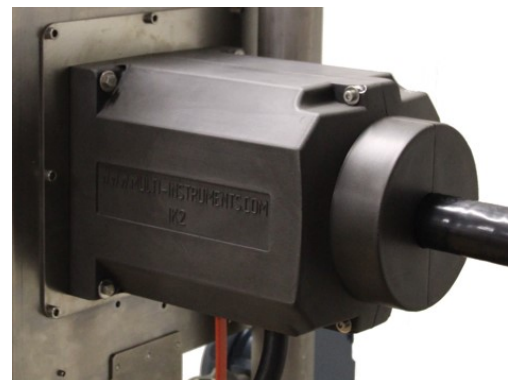
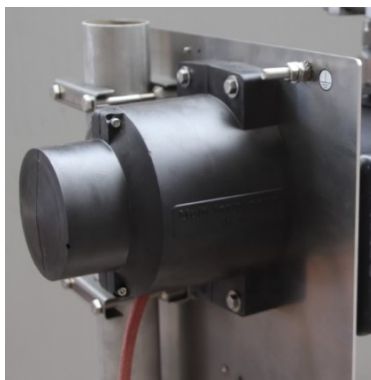
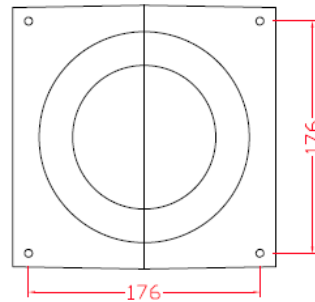
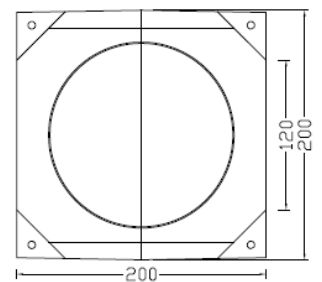

Head Office: ☎ +31 (0)183 62 88 88 or ✉ to: instrumentation@multi-instruments.com

US + Canada: ☎ +1 587 269 49 88 or ✉ to: solutions@multi-instruments.com

for additional information: 🌐 www.multi-instruments.com